

9001778805 (021219)

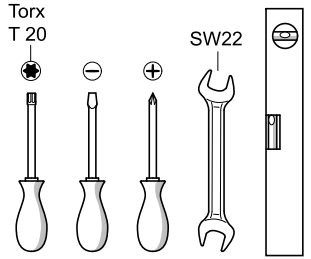

- de** Montageanleitung
- en** Installation instructions
- fr** Notice d'installation
- it** Istruzioni d'installazione
- nl** Installatie-instructies
- es** Instrucciones de montaje
- pt** Instruções de instalação
- el** Οδηγίες εγκατάστασης
- da** Installationsvejledning
- no** Installasjonsveiledning
- sv** Installationsanvisningar
- fi** Asennusohjeet
- et** Paigaldusjuhised

- lt** Įrengimo instrukcijos
- lv** Uzstādīšanas instrukcijas
- pl** Instrukcja montażu
- hu** Telepítési útmutató
- cs** Pokyny k instalaci
- sl** Navodila za montažo
- uk** Інструкція з монтажу
- kk** Орнату нұсқаулықтар
- ru** Инструкция по установке
- tr** Kurulum talimatları
- ro** Instrucțiuni de instalare
- sk** Pokyny na inštaláciu
- ar** تعليمات التركيب

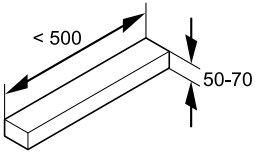
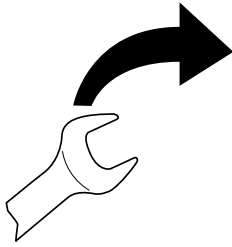
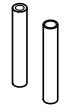
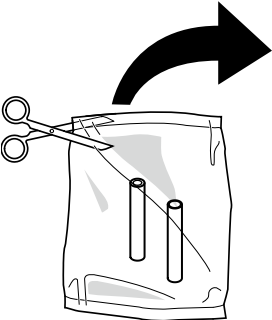

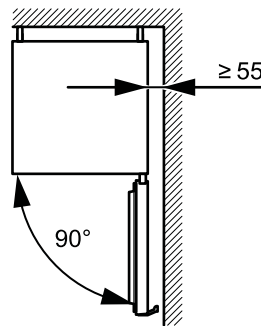
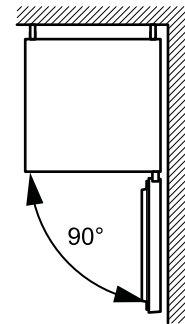
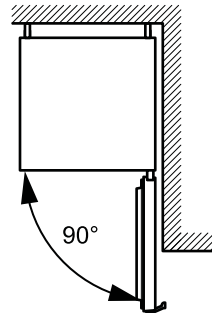
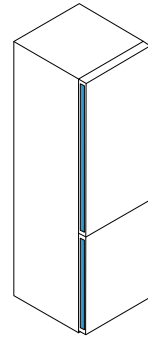
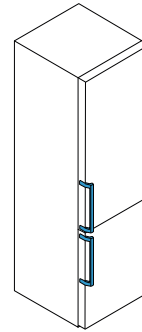
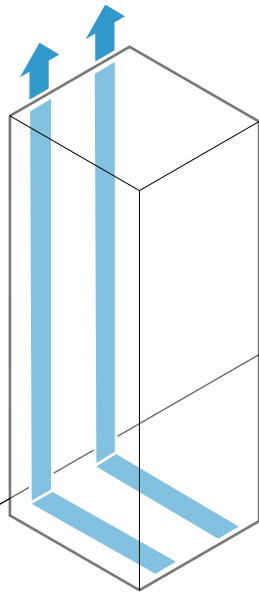
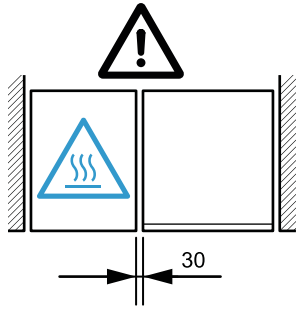
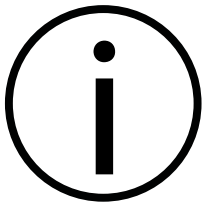

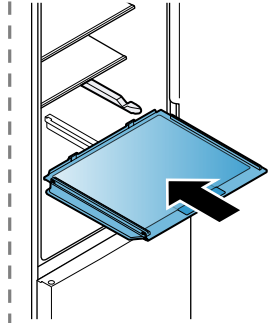
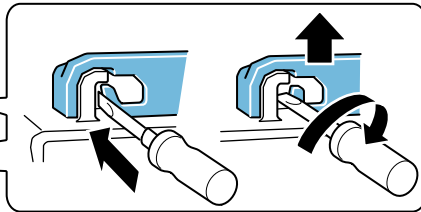
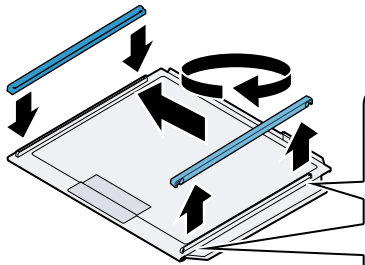
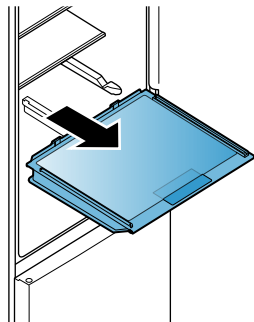
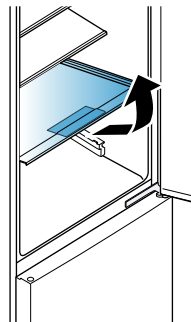
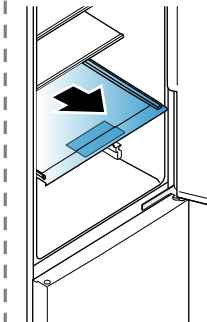
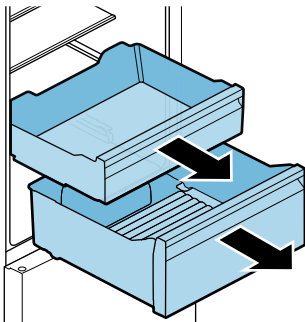
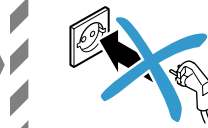
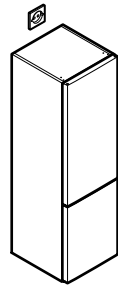
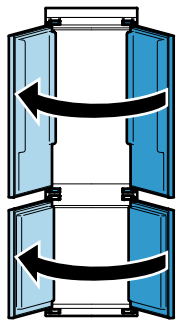
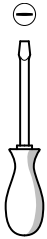
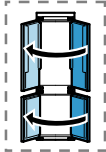

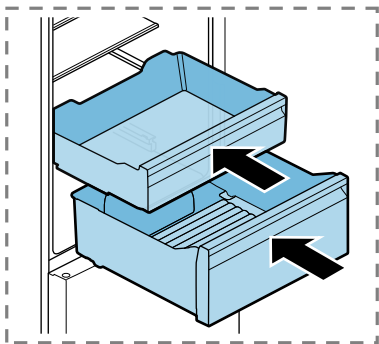
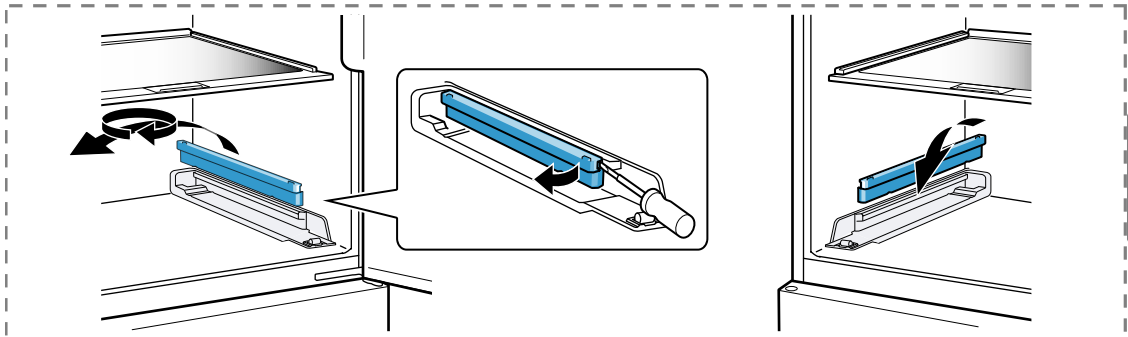
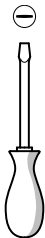
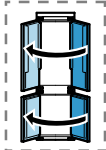

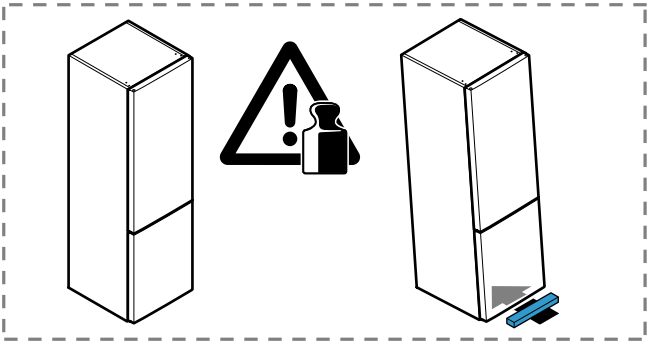
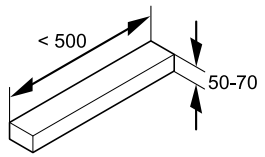
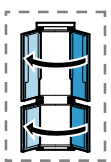

Torx
T 20

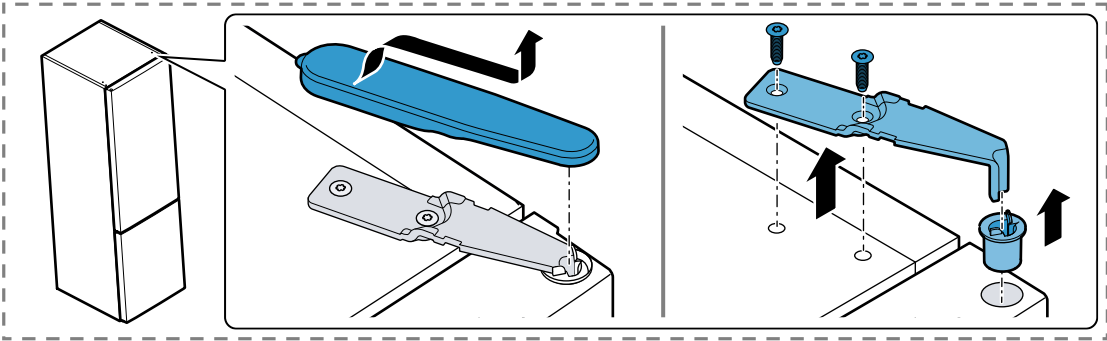
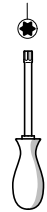

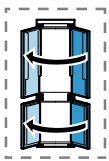

Torx
T 20

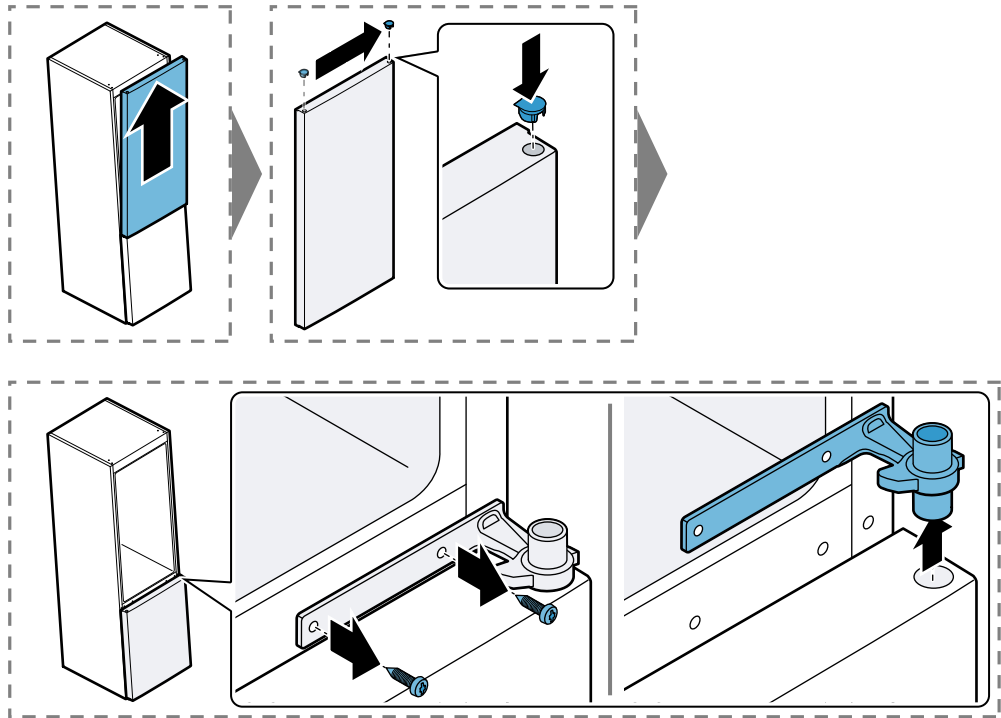

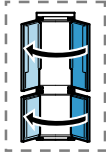

Torx
T 20

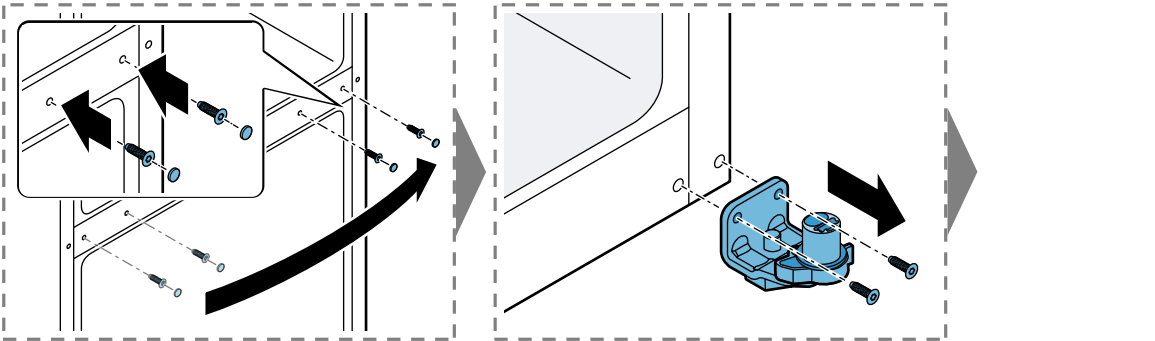
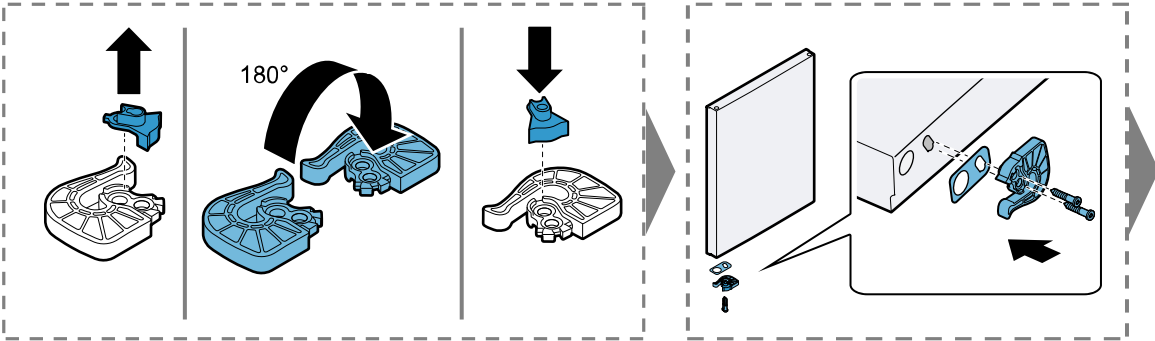
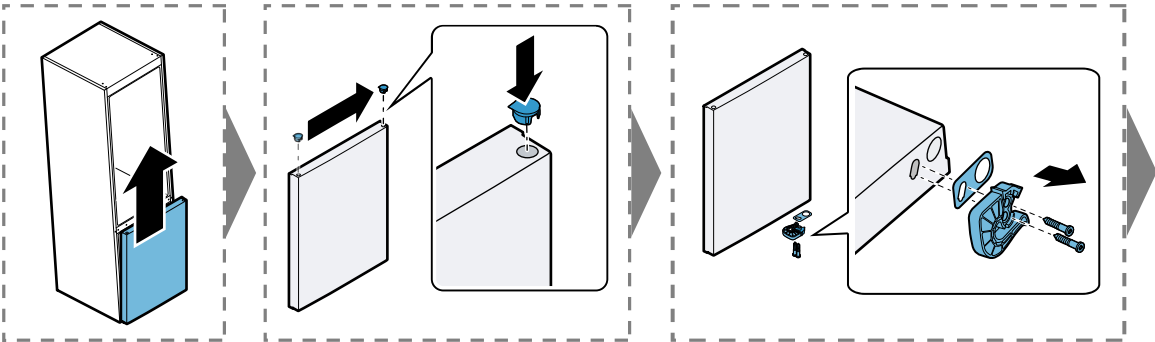
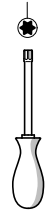

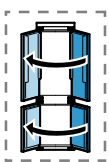

Torx
T 20

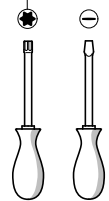

SW22

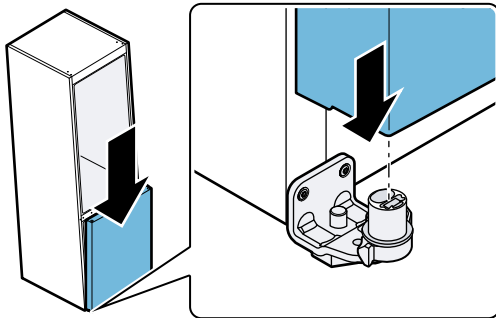
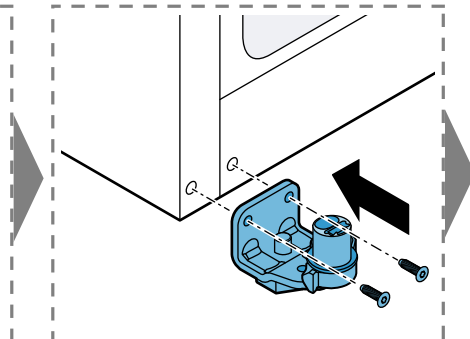
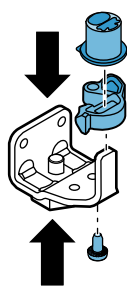
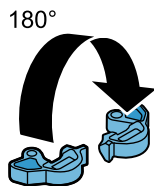
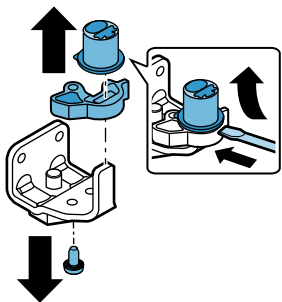
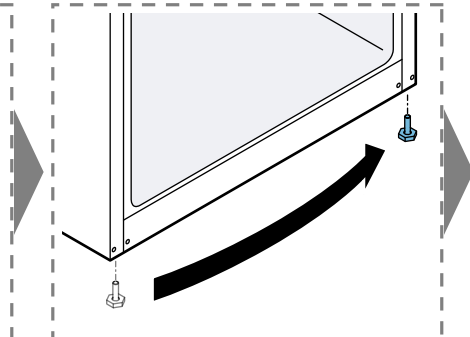
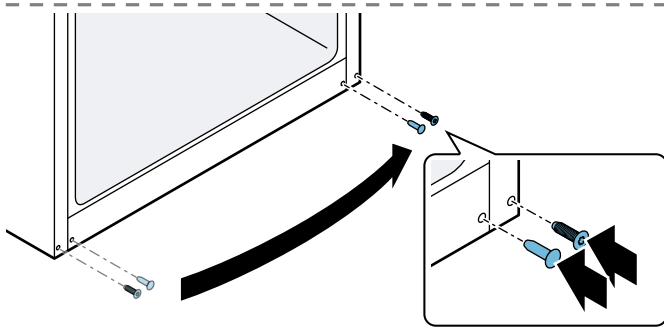
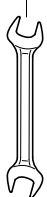

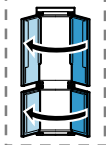

Torx
T 20

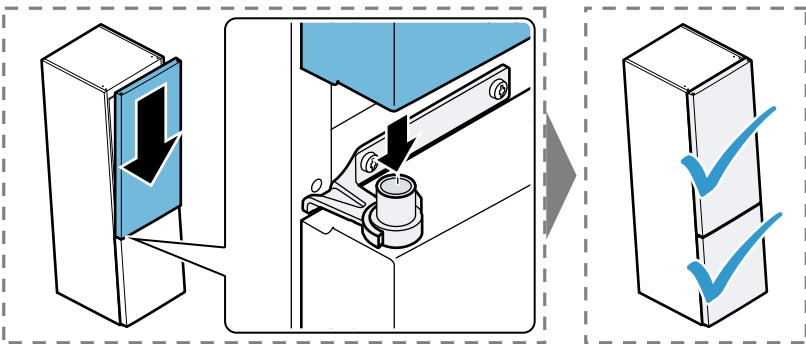
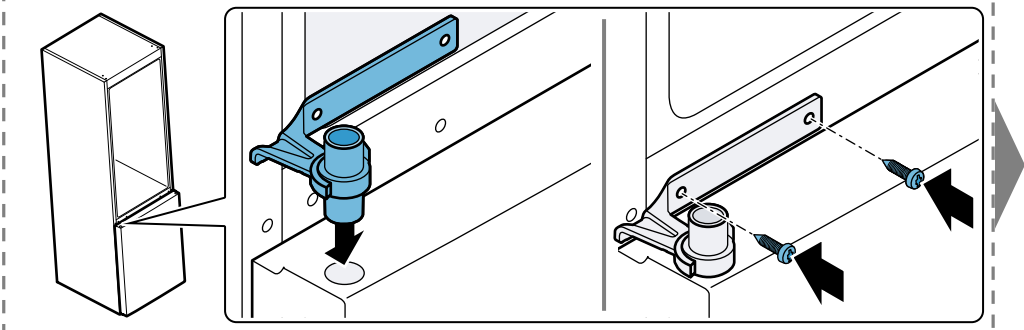
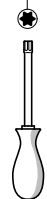

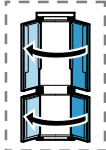

Torx
T 20

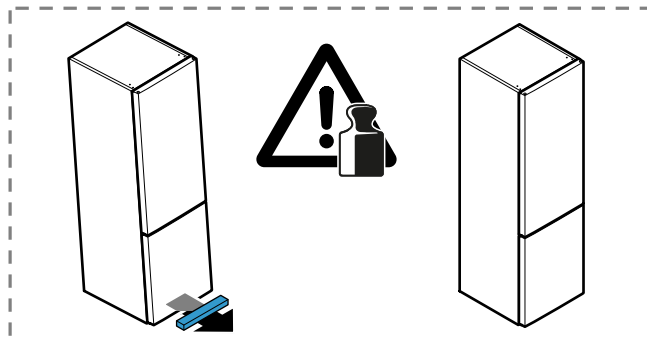
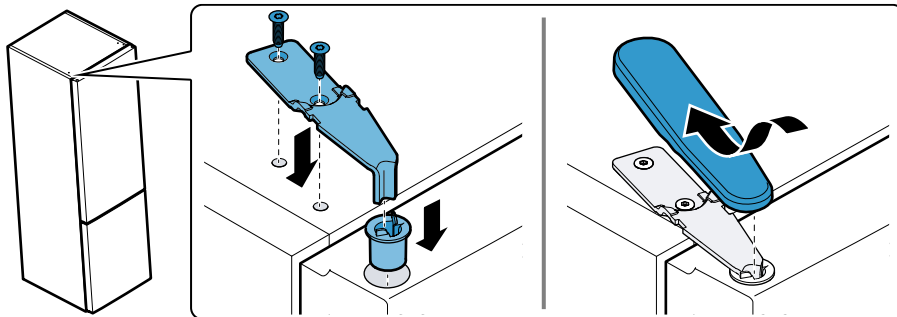
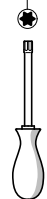

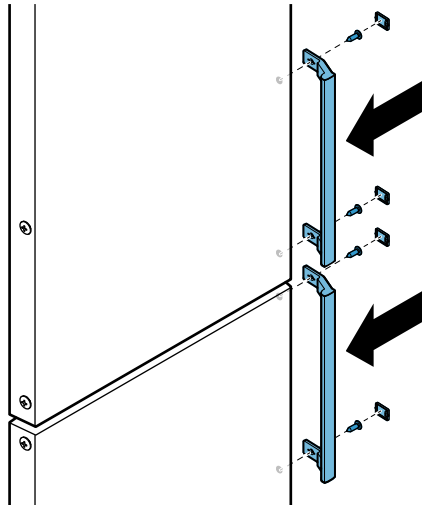
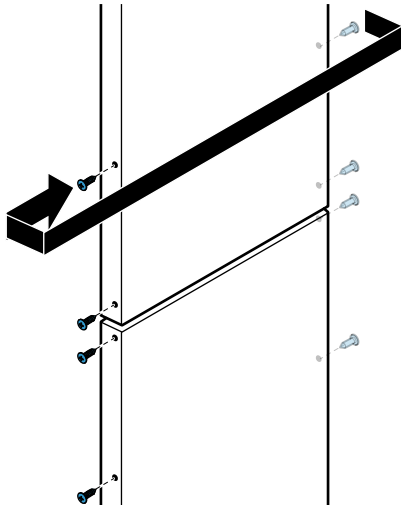
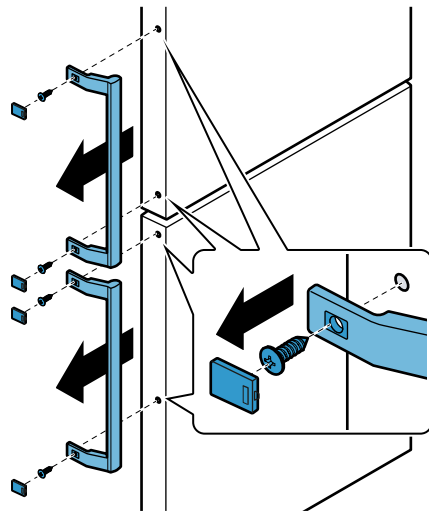
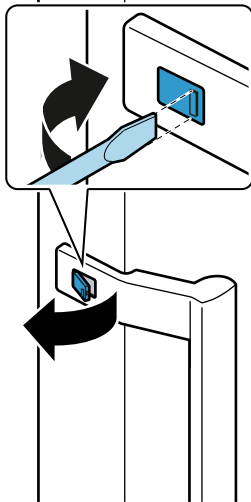
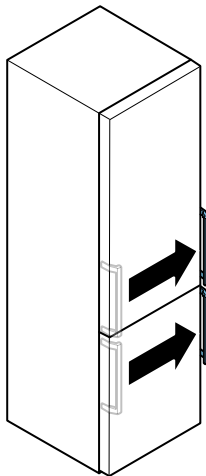
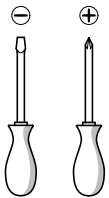
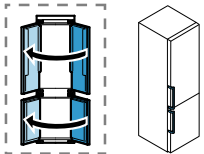

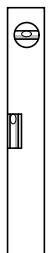
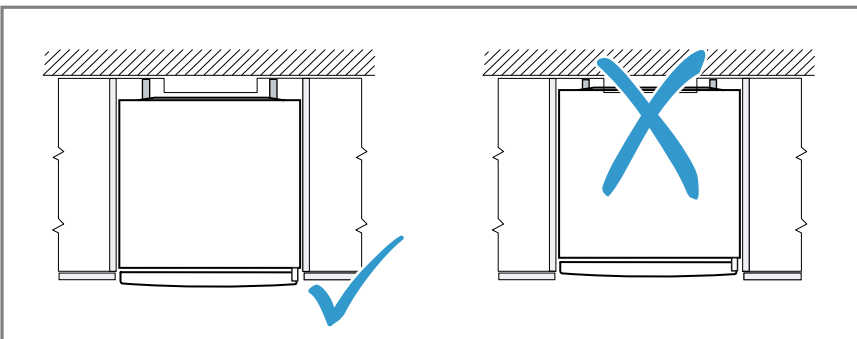
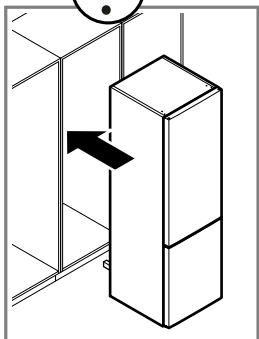
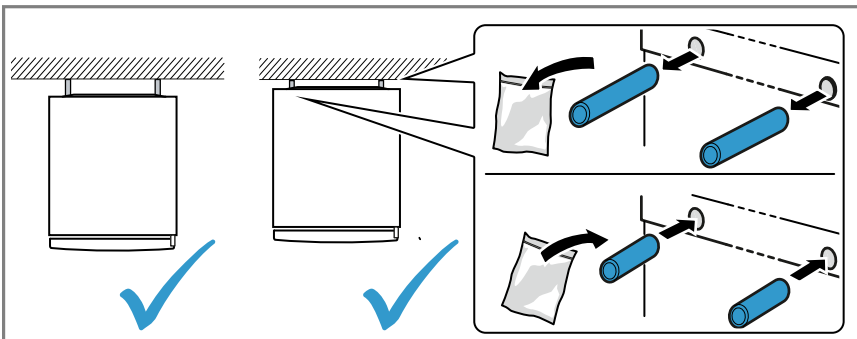
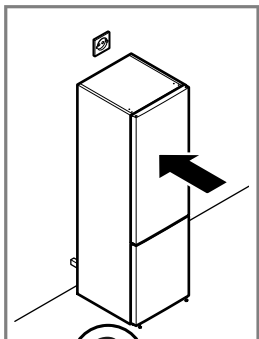
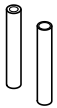

SW22

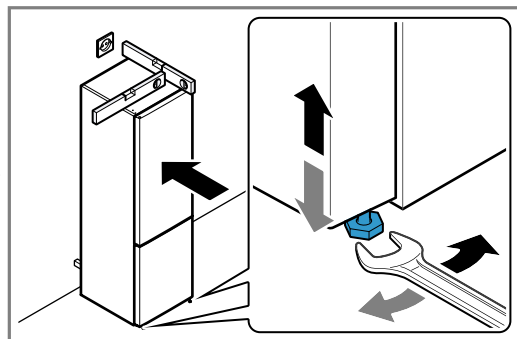
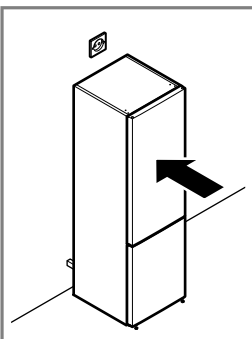
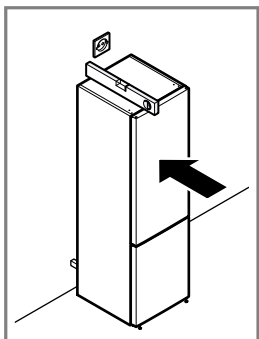
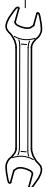



A series of horizontal lines for writing, starting from the top of the page and extending to the bottom, with a vertical margin line on the left side.

